

le
SON

SWISS MADE

High End Audio Manufacture

SINCE 2013

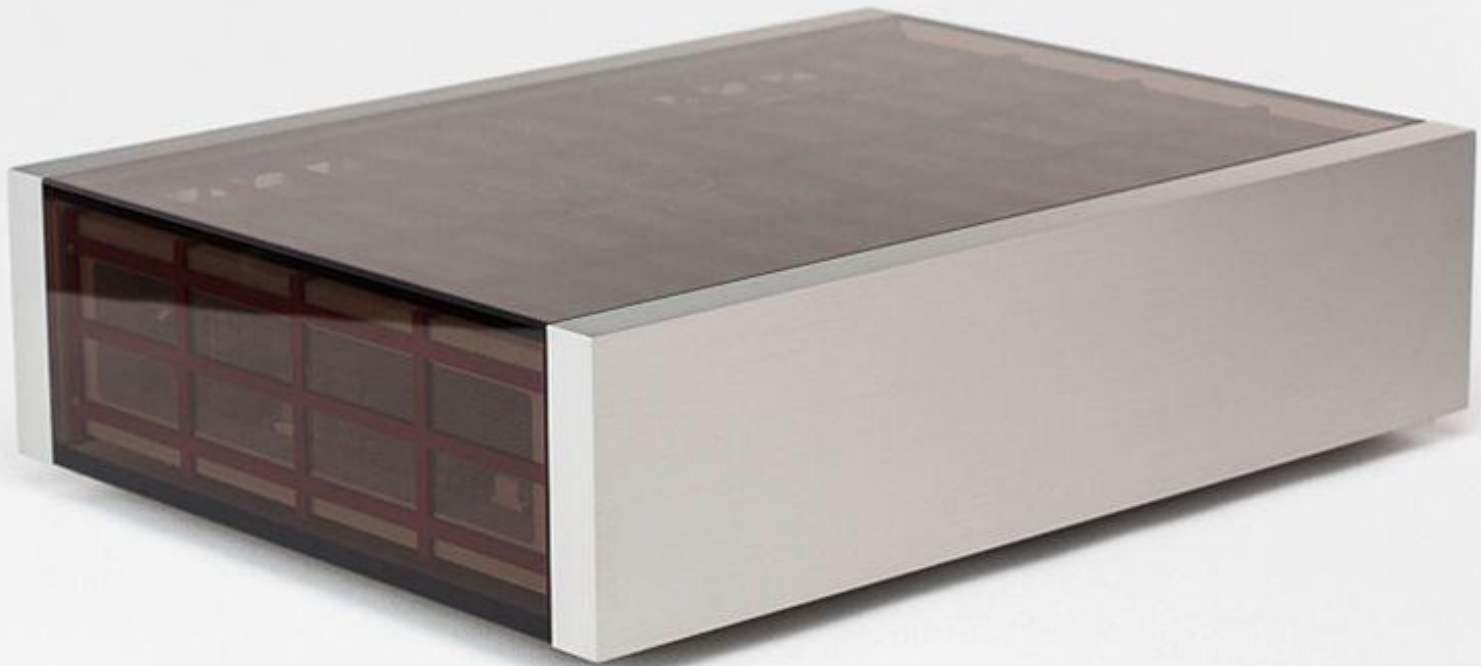

Prestige for the ear... but also for the eye

Le
SON

SWISS MADE

High End Audio Manufacture

SINCE 2013

emotion

„ art is an additional emotion applied to skillful technique “

Charlie Chaplin.. extract of «My life»

Inspired by the thinking of this celebrated Master, Manufacture Le Son combines artistic feeling with the most innovative technology to serve the needs of music lovers..

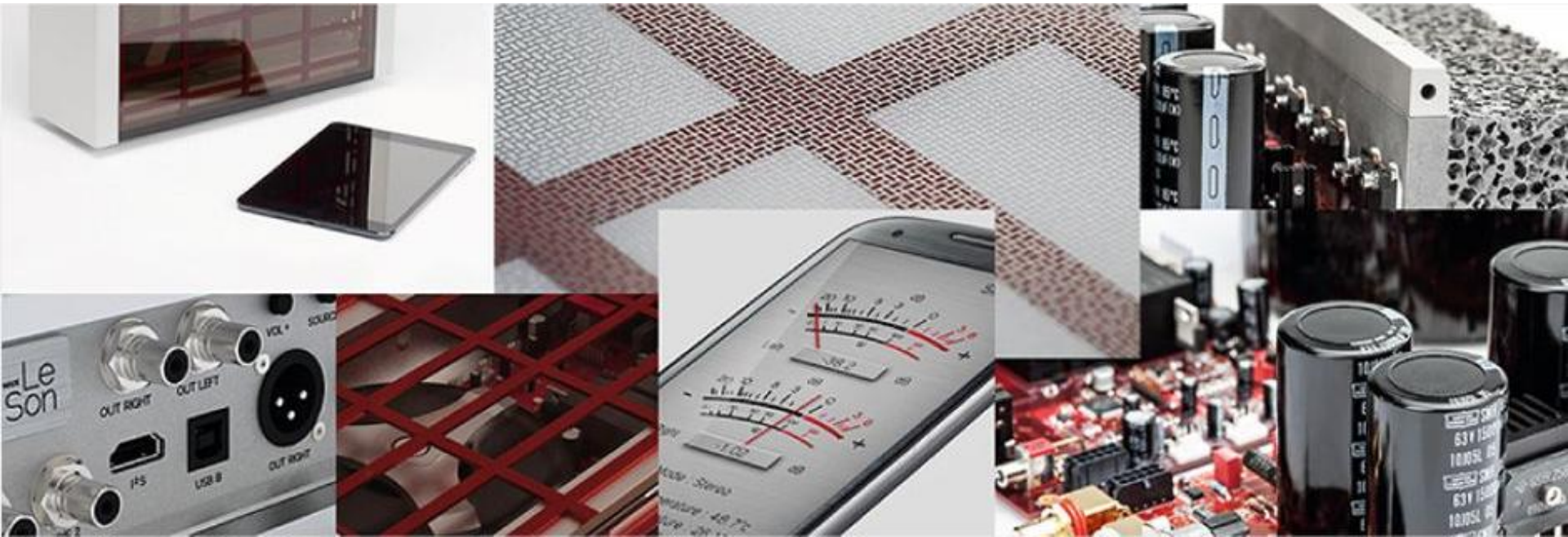



High End Audio Manufacture
SINCE 2013

swiss made

At Manufacture Le Son, both the design and the production of equipment are based on the "Swiss Made" principle normally associated with high-quality timepieces, representing more than a century of skill and knowledge in the art of designing products as luxurious and prestigious objects.





High End Audio Manufacture
SINCE 2013

swiss made

Manufacture Le Son regards the "Swiss Made" mark as more than just a label. It reflects the perfectionism in our work and the unceasing search for absolute quality which we have acquired from the greatest Swiss watch manufacturers.



Le
SON

SWISS MADE

High End Audio Manufacture

SINCE 2013

design



The Le Son design epitomises purity – purity of lines, purity of materials and purity of sound. The interface is totally delocalised to a smartphone application or a tablet computer, leaving an object of restrained elegance which harmonises with every environment by virtue of its horizontality and verticality.

Le
SON

SWISS MADE

High End Audio Manufacture

SINCE 2013

design



Transparency throws a spotlight on the care taken over each component of the architecture which lies at the heart of the device.

By their design, Le Son products inspire and sublimate each space.

Le
SON

SWISS MADE

High End Audio Manufacture

SINCE 2013

design



Transparency throws a spotlight on the care taken over each component of the architecture which lies at the heart of the device.

By their design, Le Son products inspire and sublimate each space.

high end & innovation

Manufacture Le Son innovates in technical, aesthetic and ergonomic features. A sober and elegant design harbours and exposes audio circuits of the highest performance. Manufacture Le Son offers exclusive products which are entirely designed, manufactured and assembled in Switzerland.

state of the art electronic

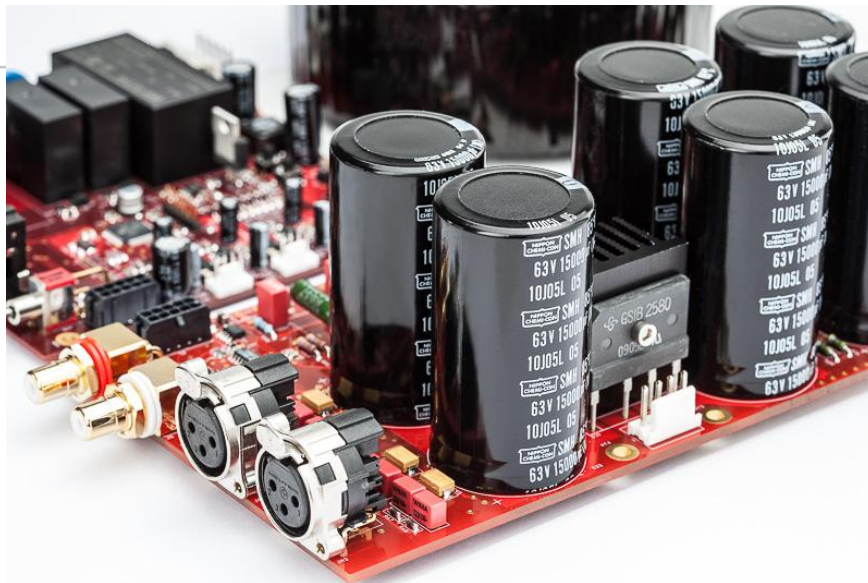

Le Son research and development team mixed the latest digital technologies and finest analog circuits to create an outstanding music reproduction experience:

- ultimate digital audio streaming,
- extremely low jitter clocking,
- powerful digital data processing,
- low noise and high speed analog circuits as well a unique amplification concept.

high end & innovation

Manufacture Le Son innovates in technical, aesthetic and ergonomic features. A sober and elegant design harbours and exposes audio circuits of the highest performance. Manufacture Le Son offers exclusive products which are entirely designed, manufactured and assembled in Switzerland.



aluminium foam cooling system

Aluminum foam has fantastic acoustic, aesthetic and cooling features. The very large complex surface makes an efficient heat-sink. Low-speed silent fans are precisely controlled in accordance with the temperature and the listening level.

high end & innovation

Manufacture Le Son innovates in technical, aesthetic and ergonomic features. A sober and elegant design harbours and exposes audio circuits of the highest performance. Manufacture Le Son offers exclusive products which are entirely designed, manufactured and assembled in Switzerland.



aluminium foam cooling system

Aluminum foam has fantastic acoustic, aesthetic and cooling features. The very large complex surface makes an efficient heat-sink. Low-speed silent fans are precisely controlled in accordance with the temperature and the listening level.

high end & innovation

Manufacture Le Son innovates in technical, aesthetic and ergonomic features. A sober and elegant design harbours and exposes audio circuits of the highest performance. Manufacture Le Son offers exclusive products which are entirely designed, manufactured and assembled in Switzerland.

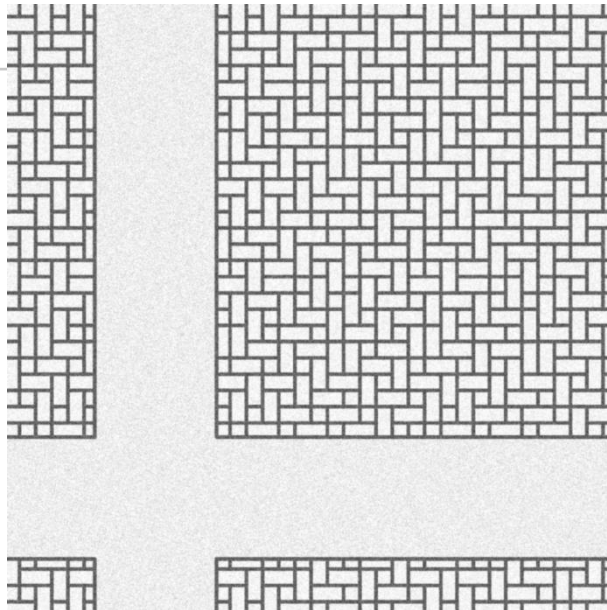

EMI and RFI shielding

A thin chemical milled metal grid provides strong shielding against electromagnetic and radio frequency interferences while preserving the product transparency and unique design.



High End Audio Manufacture
SINCE 2013

high end & innovation

Manufacture Le Son innovates in technical, aesthetic and ergonomic features. A sober and elegant design harbours and exposes audio circuits of the highest performance. Manufacture Le Son offers exclusive products which are entirely designed, manufactured and assembled in Switzerland.



EMI and RFI shielding

A thin chemical milled metal grid provides strong shielding against electromagnetic and radio frequency interferences while preserving the product transparency and unique design.

LE
SON

SWISS MADE

High End Audio Manufacture

SINCE 2013

high end & innovation

Manufacture Le Son innovates in technical, aesthetic and ergonomic features. A sober and elegant design harbours and exposes audio circuits of the highest performance. Manufacture Le Son offers exclusive products which are entirely designed, manufactured and assembled in Switzerland.

remote user interface



The chassis design purity is preserved by choosing a remote user interface, hosted on a tablet computer or a smartphone.

Easy to ready, simple and convenient, the control application provides several real-time informations.

high end & innovation

The care lavished on technologies and components guarantees the faultless spirituality of the listening experience.

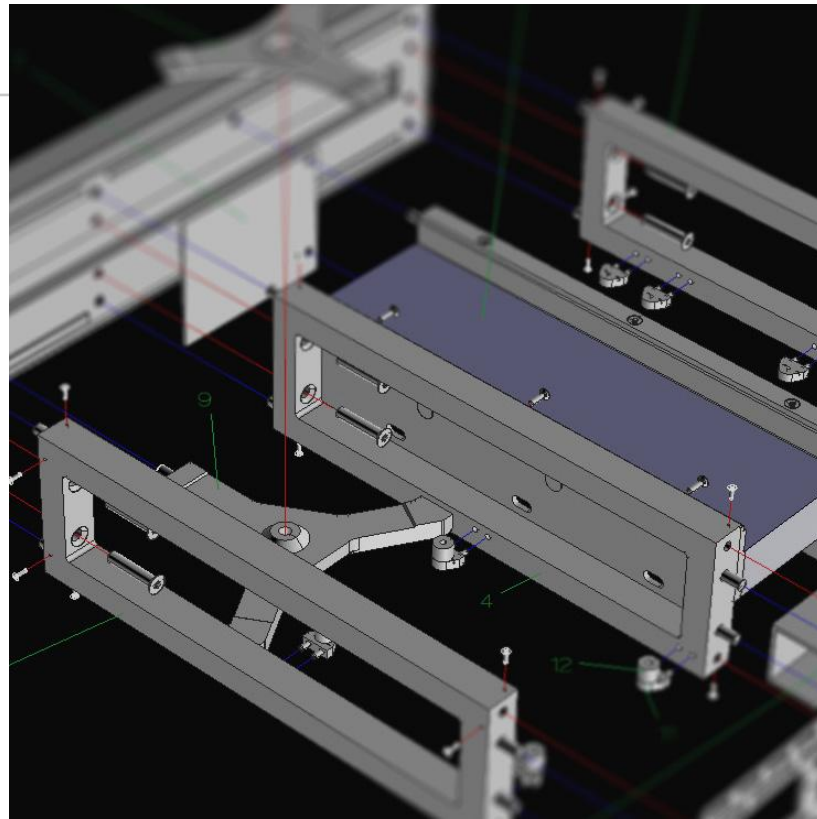

chassis made up of more than
50 mechanical parts

In order to ensure full consistency between mechanical, electrical and aesthetic constraints, nothing has been left to chance:

high precision machined parts, perfect finish, carefully selected materials and accurate build quality.

Our leitmotiv leads our work...

LE
SON

SWISS MADE

High End Audio Manufacture

SINCE 2013

high end & innovation

The care lavished on technologies and components guarantees the faultless spirituality of the listening experience.

chassis made up of more than
50 mechanical parts

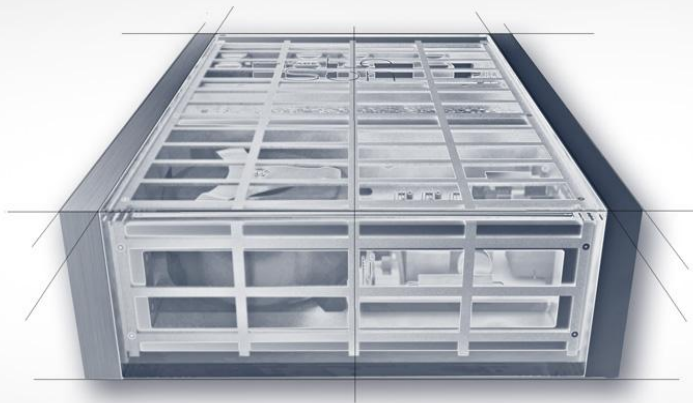

In order to ensure full consistency between mechanical, electrical and aesthetic constraints, nothing has been left to chance:

high precision machined parts, perfect finish, carefully selected materials and accurate build quality.

Our leitmotiv leads our work...

Prestige for the ear... but also for the eye

Le
SON SWISS MADE

High End Audio Manufacture
SINCE 2013

unique

Manufacture Le Son also makes limited runs and one-off products to match the wishes of each user.

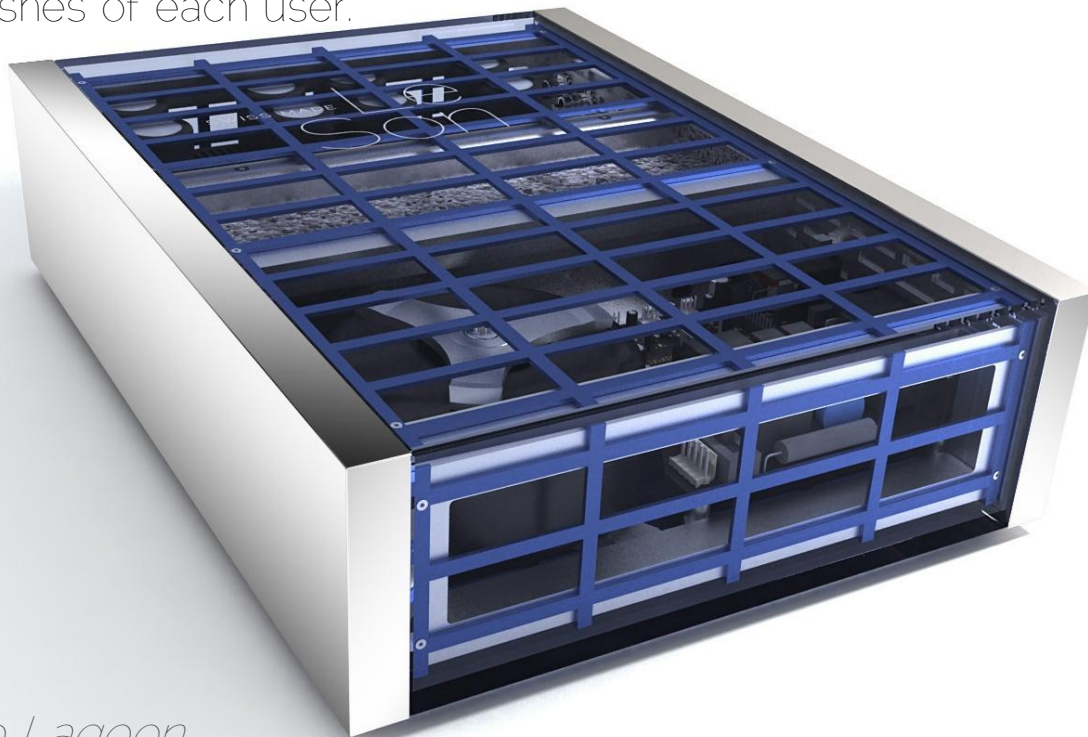

Blue Lagoon

Le
SON

SWISS MADE

High End Audio Manufacture

SINCE 2013

unique

Manufacture Le Son also makes limited runs and one-off products to match the wishes of each user.

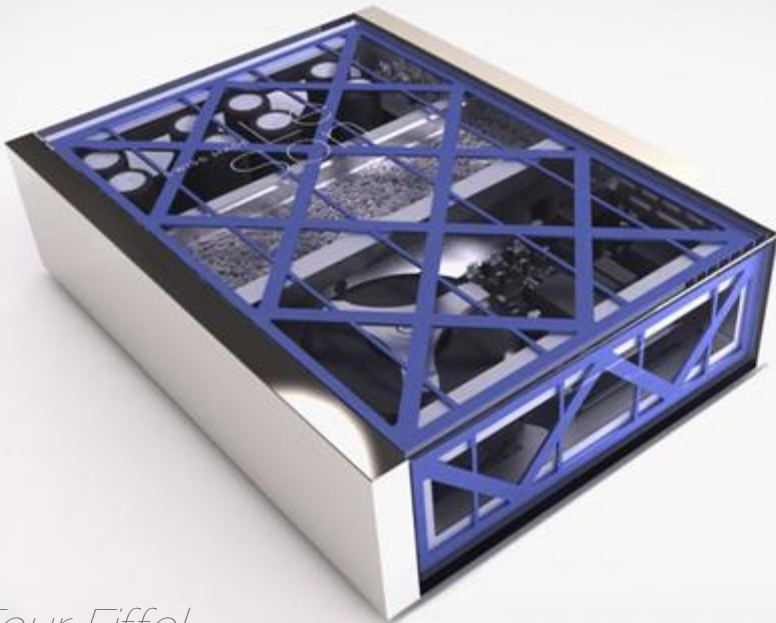

Tour Eiffel



Goldfinger

Manufacture Le Son will offer in autumn, 2013 two exceptional products

Network & USB streaming with high performance DAC

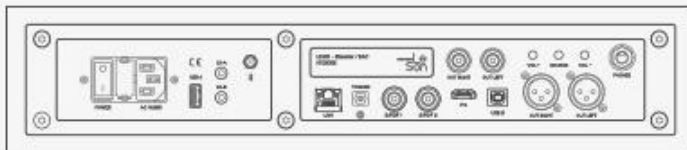

LS001 - Streamer / DAC



Stereo Amplifier A/B - 2 x 100W

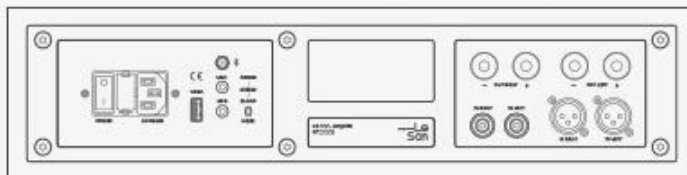

LS002 - Amplifier



Le
SON

SWISS MADE

High End Audio Manufacture

SINCE 2013

Ls001 – source – streamer / DAC



Ls001 – source – streamer / DAC

Key features

- asynchronous endpoint for USB and LAN jitter-free playback
- bit-perfect data transmission over USB and LAN
- support for high definition PCM and DSD audio
- perfect clocking concept
- ultra-low jitter oscillators, outstanding phase noise characteristics (better than -130dBc/Hz at 100Hz)
- 16x oversampling process, minimal phase filter
- 4 DACs in twin dual-mono mode
- very low-noise power supply, more than 30 voltage regulators
- full discrete mirror output stage, class A, no global feedback
- high-performance headphone output

Ls001 – source – streamer / DAC

Technical data

<i>Power consumption</i>	standby	< 1W
	operation	< 30W
<i>Control & firmware update</i>	USB-A port for memory stick Bluetooth	
<i>Network streaming</i>	<ul style="list-style-type: none"> • RJ45 connector for wired LAN • UPnP™ AV 2.0 / DLNA • asynchronous, jitter-free and bit-perfect audio data transmission 	
	supported formats	WAV, AIFF, FLAC, ALAC, MP3, AAC, WMA, DSF, DFF
	PCM	up to 192kHz 24-bit
	DSD	1-bit at 2.8224MHz
	<ul style="list-style-type: none"> • USB-B port • Audio Class 2.0 (drivers for Windows provided) • asynchronous, jitter-free and bit-perfect audio data transmission 	
	PCM	up to 192kHz 24-bit
	DSD (via DoP)	1-bit at 2.8224MHz

Ls001 – source – streamer / DAC

Technical data

<i>Digital audio inputs</i>	<ul style="list-style-type: none"> • 2x coaxial S/PDIF on RCA • optical S/PDIF on Toslink • I2S on HDMI connector 	
<i>Analog outputs</i>	unbalanced RCA balanced XLR headphones	3.0V RMS (75Ω output impedance) 6.0V RMS (150Ω output impedance) 3.0V RMS (1Ω output impedance)
<i>Frequency response</i>	+/- 0.1dB	DC to 20kHz
<i>Signal to noise ratio</i>	SNR (A-weighted)	>120dB
<i>Total harmonic distortion</i>	THD + N, 0dBFS, 24-bit	<0.001%

Ls002 – amplifler



SWISS MADE
Le
Son

High End Audio Manufacture
SINCE 2013

'Art is an additional emotion applied to skillfull technique'

Charlie Chaplin, extract of 'My Life'

Ls002 – amplifier

Key features

- high current, massively filtered power supply
- mirror-like amplifier topology
- extremely short signal path
- single-pole concept for minimal phase shift
- optimal loudspeaker control through innovative feedback concept
- audiophile-grade internal wiring
- stereo, bi-amp and mono (parallel) configuration

Ls002 – amplifier

Technical data

<i>Chassis</i>	Size	426 x 106 x 320 mm
	Weight	19.2 kg
<i>Power consumption</i>	standby	< 1W
	idle	< 20W
<i>Control & firmware update</i>	USB-A port for memory stick	
	Bluetooth	
<i>Analog inputs</i>	Unbalanced	2x RCA (10kΩ input impedance)
	Balanced	2x XLR (10kΩ input impedance)
<i>Nominal output power</i>	stereo & bi-amp	2x 100W / 8Ω
<i>Frequency response</i>	0dB/-3dB, 1W	1Hz to 350kHz
<i>Signal to noise ratio</i>	SNR (A-weighted)	>115dB
<i>Total harmonic distortion</i>	THD, 10W 8Ω	<0.1%



High End Audio Manufacture
SINCE 2013

products

system with one
LS001 - *streamer/DAC* - ar
one LS002 - *amplifier* - in stereo



system with one
LS001 - *streamer/DAC* - and
two LS002 - *amplifier* - in mono mode

